

IRWIN®



MERCHANDISING CATALOGUE 2014

■ PEG WALLS	
■ PEG WALLS & ACCESSORIES	4
■ HOOKS FOR PEG WALLS	6
■ ADDITIONAL ACCESSORIES	7
■ BLUE PLASTIC WALLS	9
■ POLISH PEG WALLS & HANGERS	10
■ CIRCULAR SAW BLADES DISPLAYS	11
■ DISPLAYS	
■ MIXED PRODUCTS	13
■ DRILLING	15
■ WORKHOLDING & CLAMPING	17
■ WOODWORKING	18
■ LAYOUT TOOLS	19
■ ROLL-UP BANNERS ON DEMAND	20





3 HEADER

5 MEDIUM DISPLAY RAIL

Space between the wall and the rail.



7 SEPARATORS



8 SHELF (INC. 18 DIVIDERS)

Two positions (flat and angled); for small boxes (i.e. hole saws).

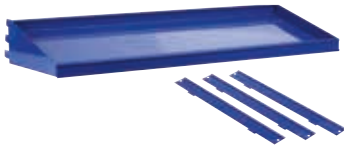

2 LEG

Either side.

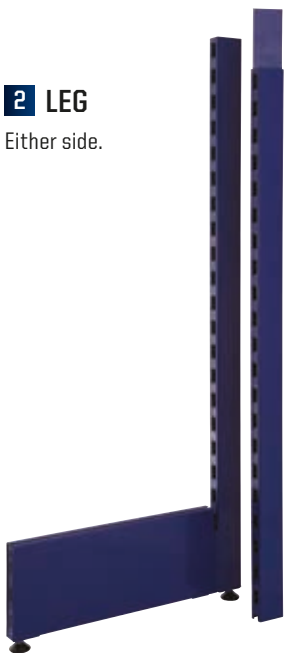

10 DRAWER

Allows additional product storage

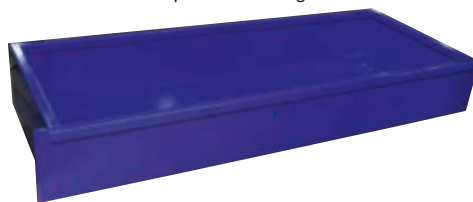

4 LIGHT KIT

6 SMALL DRILL RAIL

Contains up to 38 single hooks; for small products.



9 SMALL DISPLAY RAIL

Hooks slide onto rail, hung over the wall.



1 PEGWALL STRUCTURE

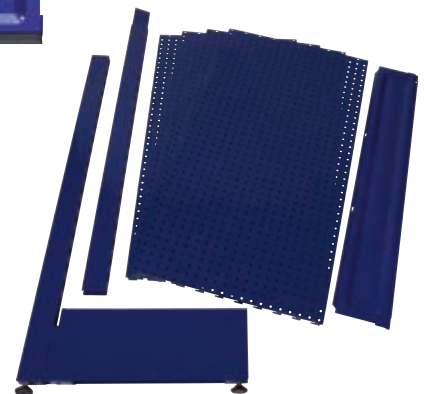

KIT

100 CM PEG WALL	90 CM PEG WALL	STAND-ALONE	EXTENSION OF EXISTING	DESCRIPTION
				<p>MERCHANDISER PEGWALL KIT INCLUDES: 1 Wall / 1 Header / 1 Light Kit / 1 Leg</p> <p>NB:</p> <p>For 1 metre Peg Wall: Order 1 peg wall structure, 1 Leg, 1 header & 1 light kit.</p> <p>For 2 metre Peg Wall: Order 2 peg wall structures, 1 Leg, 2 headers & 2 light kits.</p> <p>(Product not included)</p>
		PEG WALL STRUCTURE + 1 LEG	PEG WALL STRUCTURE ALONE	

COMPONENTS

100 CM PEG WALL	90 CM PEG WALL	NO.	PICTURE	DESCRIPTION
SKU NO.	SKU NO.			
10507619	10507733	1		<p>PEGWALL STRUCTURE 2 sizes: 55 x 100 x 220 cm 55 x 90 x 220 cm INCLUDES: 1 Wall / 1 leg SEE NB ABOVE</p>
10507623	10507623	2		<p>LEG: 1 Leg 220 cm SEE NB ABOVE</p>
10507618	10507735	3		<p>HEADER: Permanent Header / Light Box (Neon not included)</p>
10507622	10507622	4		<p>LIGHT KIT: 1 Neon Light 1 Power Cable Schuko Plug Optional cable to chain several lighting units NB: Fits both 90 cm and 100 cm dimensions</p>
10507625*	N/A			<p>LIGHT KIT UK 100 cm (UK Plug)</p>

ACCESSORIES

100 CM PEG WALL	90 CM PEG WALL	NO.	PICTURE	DESCRIPTION
SKU NO.	SKU NO.			
10507749*	10507737	5		<p>MEDIUM DISPLAY RAIL NB: Comes with plastic ticket rail</p>
10507747	N/A	6		<p>SMALL DRILL RAIL NB: Comes with plastic ticket rail</p>
10507751*	10507751*	7		<p>SEPARATORS: 2 Pieces Labels need to be ordered locally NB: Fits drill rails only</p>
10507746	10507738*	8		<p>SHELF (INC 18 DIVIDERS) 2 sizes: 100 x 37 cm & 37 x 90 cm INCLUDES: 1 shelf 18 pcs dividers</p>
10507748	10507736	9		<p>SMALL DISPLAY RAIL</p>
10508083	N/A	10		<p>DRAWER: NB: Only available for size 100 cm</p>

ACCESSORIES - HOOKS

SKU NO.	NO.	PICTURE	DESCRIPTION
10505974	1 (p6)		<p>UNIVERSAL EURO HOOK 120 mm 25 pc/ Pack</p>
10505975	2 (p6)		<p>UNIVERSAL EURO HOOK 200 mm 25 pc/ Pack</p>
10505973	3 (p6)		<p>SINGLE EURO HOOK 200 mm 25 pc/ Pack</p>
10505976	4 (p6)		<p>UNIVERSAL EURO HOOK 60 mm 10 pc/ Pack</p>

* Available while stocks last

1 UNIVERSAL EURO HOOK



SKU NO.	SIZE	DESCRIPTION
10505974	Length: 120mm	PACK OF 25 PIECES Fit in wall or rail

2 UNIVERSAL EURO HOOK



SKU NO.	SIZE	DESCRIPTION
10505975	Length: 200mm	PACK OF 25 PIECES Fit in wall or rail

3 SINGLE HOOK



SKU NO.	SIZE	DESCRIPTION
10505973	Length: 200mm	PACK OF 25 PIECES Fit in wall or rail Note: For security place the single hooks at a height of more than 1,8 metres or with a drill rail

4 UNIVERSAL EURO HOOK



SKU NO.	SIZE	DESCRIPTION
10505976	Length: 60mm	PACK OF 10 PIECES Fit in wall or rail

Price flags can be added to the end of the hooks.
All the hooks fit the 100 cm and 90 cm Peg Walls.

1 IRWIN® LCD KIT

Fits in all type of walls (peg wall, displays for mixed products).
Easy to place and move around in-store to promote specific products.
Films provided locally are stored on an easy-to-change memory card.



*Available while stocks last

SKU NO.	SIZE	DESCRIPTION
10507959*	23 cm x 16 cm	Screen
	44 cm	Arm

COMPONENTS

Screen / Arm / Cable / Drill Bits & Screws to fix to any Wall

2 SAW RACKS

Contains 6 saws.
Choose the size of the rack according to the length of the Saws

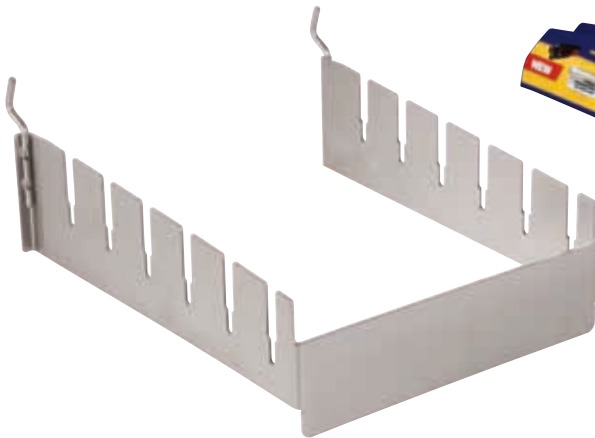

SKU NO.	SIZE	DESCRIPTION
10506517*	30 cm x 22 cm	Saw Rack for 6 Long Saws
10506518	20,5 cm x 22 cm	Saw Rack for 6 Universal Saws

* Available while stocks last

5 ONE-HANDED BAR CLAMP HOOKS

For holding up-to 5 one-hand bar clamp



SKU NO.	SIZE	DESCRIPTION
10506376	Length: 22cm	One-Handed Bar Clamp Hook Pack of 6 pieces

6 PRO CLAMP HOOK

For Holding up to 6 traditional clamps



SKU NO.	SIZE	DESCRIPTION
10506375	Length: 16cm	Pro Clamp Hook Pack of 6 pieces

7 BUS STOP HOOKS

Posters need to be ordered locally.



SKU NO.	SIZE	DESCRIPTION
1924881	Length: 48.5cm	Bus Stop Hook

1 PLASTIC MODULE

Useful to convert regular wall into IRWIN® wall

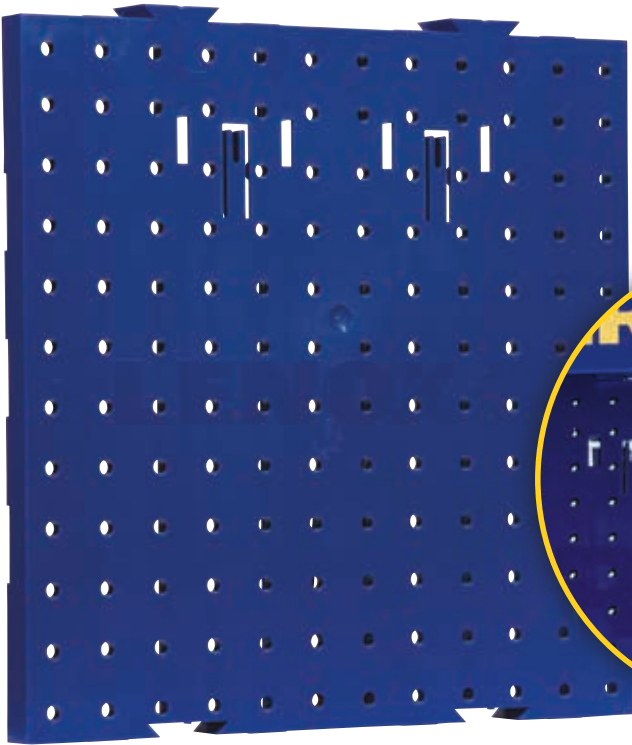

2 PLASTIC WALL HEADER

Clips on to the Plastic Module, no need to add hooks to hang it.



SKU NO.	SIZE	DESCRIPTION
P03780002E	31 cm x 31 cm	Blue Module

SKU NO.	SIZE	DESCRIPTION
P03780003E	31 cm x 8 cm	Wall header

3 WIRE HANGER BRACKETS



SKU NO.	SIZE	DESCRIPTION
P03780004E	31 cm	Hanger Brackets for Plastic Module

1 IRWIN® WALL

Only one reference to order the complete peg wall.
Please order special hangers separately.
Possibility to use the euro hooks (see page 6).

SKU NO.	SIZE	DESCRIPTION
TREGALIRWIN	90 cm x 220 cm x 15 cm	IRWIN® Wall

COMPONENTS

Body

Header

Light Kit

2 Legs

2 HANGER FOR JACK® HAND SAWS

Hanger for 10 Hand Saws.

SKU NO.	DESCRIPTION
TZAWIESZKAJACK	Hanger for Jack® Handsaws

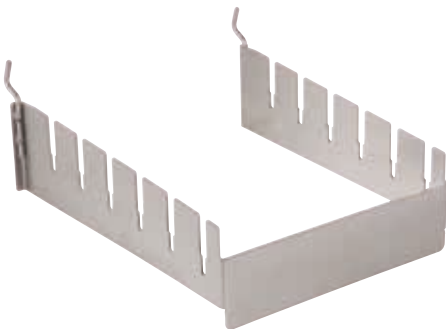

3 SPEEDHAMMER HANGER

12 hooks for SPDH Plus/ Power drill bits.

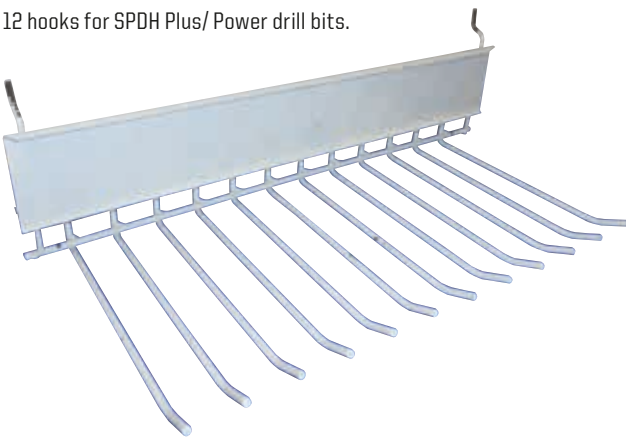

SKU NO.	DESCRIPTION
10506552*	Speedhammer™ Hanger

* Available while stocks last



4 GROUP HANGER 9-HOOKS

9 hooks hanger for drill bits (for drill bits in tubes over 14 mm diameter + drill bits with euro hanger).

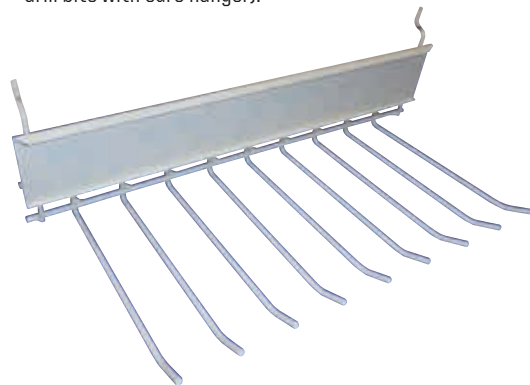

SKU NO.	DESCRIPTION
TZAWIESZKAGR9*	Group Hanger 9-Hooks

CIRCULAR SAW BLADES



CIRCULAR SAW BLADES FSDU

Robust and impactful, this metal display offers the possibility to place multiple sizes of blades (small, medium and large) on each wireframe. The wireframe can hold up to 8 hooks which can be clipped onto both sides. The display is made from four, easy-to-assemble, main parts. It includes a transparent visual holder which can be clipped onto the wireframe to display a communication poster (490mm wide x 510mm high).

Average blades capacity: 100

Max. blades capacity: 192



Display dimensions: 187 cm x 70 cm

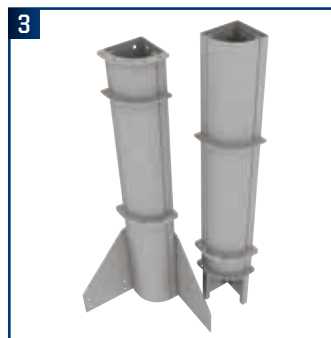
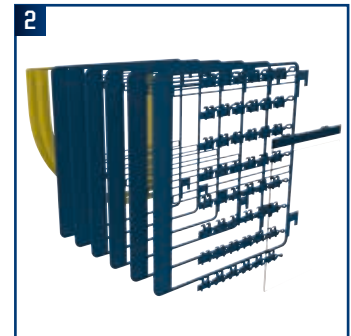

ACCESSORIES

SEGMENTATION STICKER KIT

Ease the search of blades by segmenting the display with some stickers to be placed on the wireframe and yellow bars.

Available in multiple languages. See more details page 14.

HANDHELD

HANDHELD

5 PRICE TAGS

Indicate the price with the transparent Plastic price tags. Pack of 32 pieces.



SKU NO.	DESCRIPTION	DIMENSIONS (cm)	WEIGHT (kg)
1	1921614 CSB FSDU Display, 1/4 Base and Top	79 x 79 x 30	25
2	1921822 CSB Small Floor Display, 2/4, 6 Wire Frames	63 x 61 x 16	30
3	1921823 CSB Small Floor Display, 3/4, Pillar	134 x 50 x 35	25
4	1921824 CSB Small Floor Display, 4/4, Visuals	100 x 60 x 8	4
5	1925942 Pack of 32 Price Tags	15 x 10 x 2	0.3

CIRCULAR SAW BLADES RACK

Robust and smart solution for the 90 cm and 100 cm peg walls. Each rack comes with 4 wireframes and has 2 additional slots available behind the back panels to place 2 extra wireframes (to be ordered separately). One peg wall can contain 2 racks.

This metal display offers the possibility to place multiple size of blades (small, medium and large) on each wireframe. The wireframe can hold up to 8 hooks which can be clipped onto both sides. The display is made from four, easy-to-assemble, main parts. It includes a transparent visual holder which can be clipped onto the wireframe to display a communication poster (490mm wide x 510mm high). An additional visual holder is also attached to one back panel to display a communication poster: 90 cm Rack = 250mm (w) x 420mm (h); 100 cm Rack: A3 (portrait).

Average blades capacity: 100

Max. blades capacity: 192

Max. blades capacity with 2 extra wireframes: 256

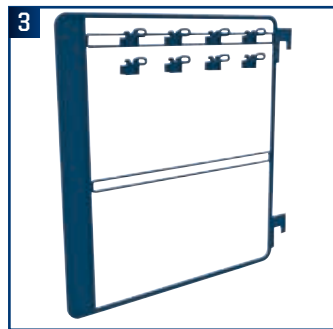
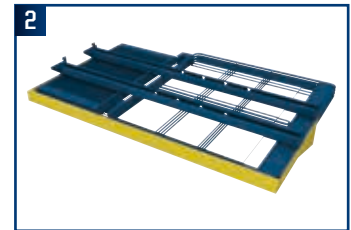
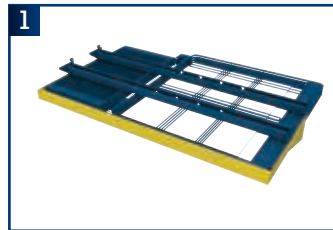

ACCESSORIES

SEGMENTATION STICKER KIT

Ease the search of blades by segmenting the display with some stickers to be placed on the wireframe and yellow bars.

Available in multiple languages. See more details page 14.

HANDHELD

HANDHELD

4 PRICE TAGS

Indicate the price with the transparent Plastic price tags. Pack of 32 pieces.



5 BUS STOP HOOK

Perfect solution to display promotional messages or product information. The hook goes the leg of the peg wall. Pack quantity: 1







SKU NO.	DESCRIPTION	DIMENSIONS (cm)	WEIGHT (kg)
1	1921826 CSB Rack Display 90cm	102 x 39 x 17	12
2	1921825 CSB Rack Display 100cm	102 x 39 x 17	12
3	1921828 1 Extra Wire Frame with 8 Hooks	63 x 61 x 5	5
4	1925942 Pack of 32 Price Tags	15 x 10 x 2	0.3
5	1924881 Bus Stop Hook	53 x 18 x 1	0.22

CIRCULAR SAW BLADES STICKER KITS





Ease the search for the correct blade by segmenting your display with stickers! The kits are available in multiple languages. Each kit is composed of blue stickers to fit the displays' wireframes and yellow stickers for the yellow bars:

32 Blue Stickers for Wireframes:

• HANDHELD x 4	HANDHELD
• CORDED x 4	CORDED 
• CORDLESS x 4	CORDLESS 
• MULTI x 4	MULTI
• STATIONARY x 4	STATIONARY
• TABLE x 4	TABLE 
• MITRE x 4	MITRE 
• TABLE & MITRE x 2	TABLE & MITRE 
• NON-FERROUS METAL x 2	NON-FERROUS METAL



18 Yellow Stickers for Yellow Bars:

• HANDHELD x 2	HANDHELD
• CORDED x 2	CORDED 
• CORDLESS x 2	CORDLESS 
• MULTI x 2	MULTI
• STATIONARY x 2	STATIONARY
• TABLE x 2	TABLE 
• MITRE x 2	MITRE 
• TABLE & MITRE x 2	TABLE & MITRE 
• NON-FERROUS METAL x 2	NON-FERROUS METAL



SKU NO.	DESCRIPTION	DIMENSIONS (cm)	WEIGHT (kg)
1925260	CSB Sticker Kit - English	57 x 3 x 5	0.4
1925351	CSB Sticker Kit - French	57 x 3 x 5	0.4
1925352	CSB Sticker Kit - German	57 x 3 x 5	0.4
1925353	CSB Sticker Kit - Spanish	57 x 3 x 5	0.4
1925354	CSB Sticker Kit - Italian	57 x 3 x 5	0.4
1925355	CSB Sticker Kit - Dutch	57 x 3 x 5	0.4
1925356	CSB Sticker Kit - Finnish	57 x 3 x 5	0.4
1925357	CSB Sticker Kit - Polish	57 x 3 x 5	0.4
1925358	CSB Sticker Kit - Czech	57 x 3 x 5	0.4
1925359	CSB Sticker Kit - Russian	57 x 3 x 5	0.4
1925360	CSB Sticker Kit - Lithuanian	57 x 3 x 5	0.4

1 CIRCULAR SAW BLADE HOOK

Circular Saw Blade hooks fit onto the small display rail 10507748 (100cm) and 10507736 (90cm).

NB: To be used with 60mm hooks. Rail not included

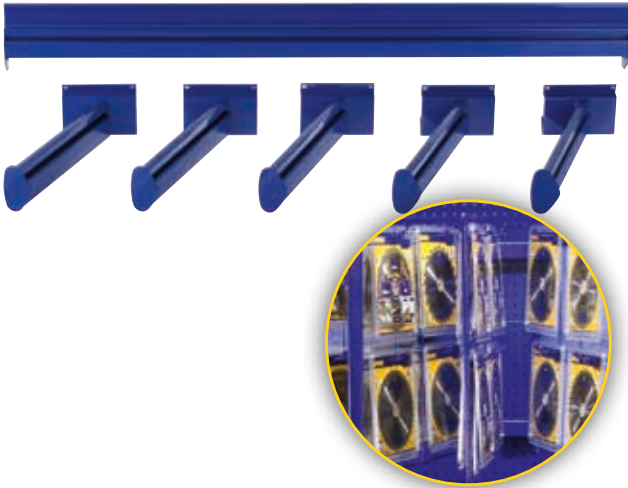

SKU NO.	SIZE	DESCRIPTION
10507750	Length: 25cm	Circular Saw Blade Hook Pack of 1 piece

2 CIRCULAR SAW BLADE HANGER

Hanger for Circular Saw Blades. Fits 90 cm peg walls.
8x 3pcs.



SKU NO.	DESCRIPTION
TZAWIESZTARCZ	Circular Saw Blade Hanger

3 DISPLAY FOR CSB SMALL

Small Display for Circular Saw Blade. Fits 90 cm peg walls.



SKU NO.	DESCRIPTION
TZAWIESZTARCZ2	Circular Saw Blade Display

IRWIN® IRWIN®



1 MIXED COUNTER-TOP DISPLAY

2 different configurations:

- 1 for Pliers
- 1 for Pliers, Drill Bits and Knives (3 Plastic Cups included)



SKU NO.	SIZE	DESCRIPTION
10507956*	34 cm x 29 cm x 42 cm	Mixed Counter-Top Display

* Available while stocks last

2 FLEXIBLE COUNTER DESK

Euro hooks need to be ordered separately.

SKU NO.	SIZE	DESCRIPTION
10508091	32 cm x 45 cm x 16 cm	Flexible Counter Desk

COMPONENTS

Counter Top display + IRWIN® sticker as a header



3 1/4 PALLET METAL DISPLAY

Shipped assembled, without products, hooks to be ordered separately

- Fit with 200 mm Euro hooks
- Wheels set optional

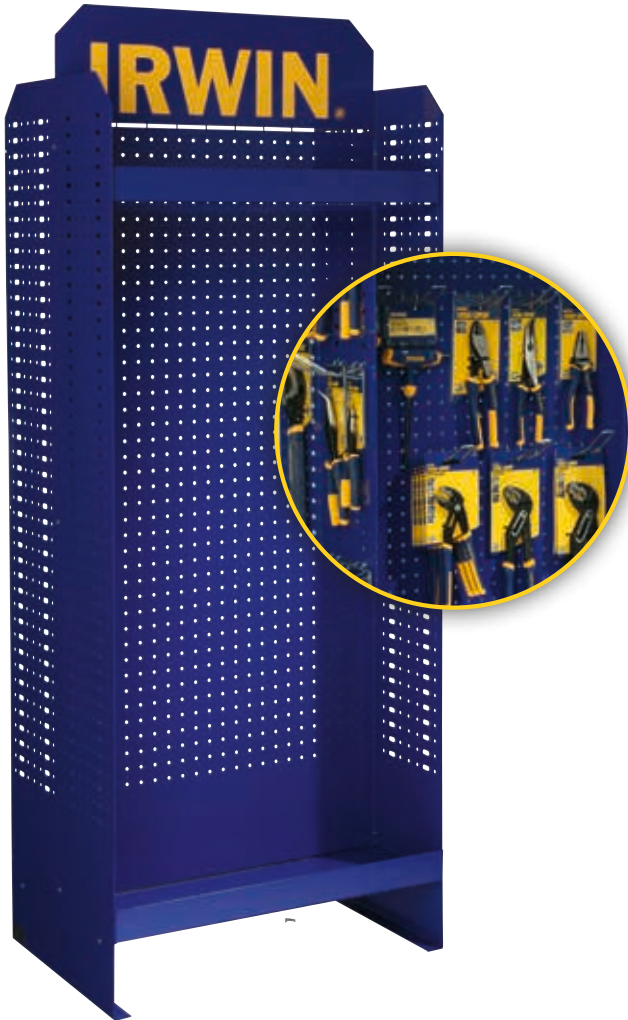

SKU NO.	SIZE	DESCRIPTION
10505220	40 cm x 60 cm x 140 cm	1/4 Pallet Metal Display

COMPONENTS
Body + 3 Shelves

4 1/4 PALLET WHEEL SET



SKU NO.	DESCRIPTION
10508082*	1/4 Pallet Wheel Set

5 FLEXIBLE METAL DISPLAY

Display is perfect to promote product concepts, new products and promotional products together with LCD Screen and wheels.

- Wheel set optional
- Hooks: order 200mm (Universal Euro Hook)



SKU NO.	SIZE	DESCRIPTION
10508089	35 cm x 45 cm x 157 cm	Flexible Metal Display

COMPONENTS
1 x Flat-packed Display / 2 x shelves (1 wide & 1 narrow)

6 WHEEL SET FOR FLEXIBLE DISPLAY



SKU NO.	DESCRIPTION
10508090	Wheel Set for Flexible Display

* Available while stocks last

1 COMPACT DRILL MERCHANDISER



2 GRANDE DRILL MERCHANDISER



RUGGED CONSTRUCTION

All parts are injection-moulded in high-impact resin.

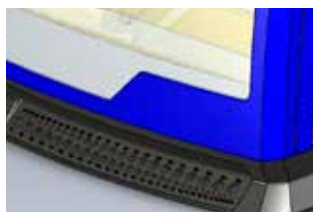

DRILL TESTER GAUGE

Existing in Metric & Fractional sizes from:
1 - 10 mm and 1/16" - 3/8" (Compact)
1 - 13 mm and 1/16" - 1/2" (Grande)



CONFIGURABLE BINS

24 different sizes or 3 shelves (Compact)
40 different sizes or 4 shelves (Grande)



CUSTOMISABLE MIX

Removable clips are provided with labels for all the different drills sizes.

SKU NO.	SIZE	DESCRIPTION
1822326	W:26cm x H: 32cm x D:22cm	Compact Drill Merchandiser

SKU NO.	SIZE	DESCRIPTION
1822035	W:41cm x H: 55cm x D:37cm	Grande Drill Merchandiser



1 VICE MERCHANDISER

Interactive merchandiser and stock holding solution.

BRANDED HEADER CARD

calling out applications of Record® vices

TRI-FOLD BROCHURE

showing full range of program and sku details
(to be printed locally)

PEG HOOK SPACE

for fiber grips or other IRWIN® Tools, 5 hooks included

STORAGE SPACE

for one of each vice on display

SHELF LABELS

with branding, description, and space for retail price

DISPLAY SPACE

for holding 5 of the top selling vices, bolts included

SKU NO.	SIZE	DESCRIPTION
10508245	60 x 50 x 120 cm	Vice Merchandiser

COMPONENTS

Body

Header

6 Hooks

Screws to fix vices

Shelf Labels



1 3-TIERED SAW BIN AND HEADER CARDS

Three-tiered saw bin can contain 36 saws.



Header Card 1 - Plus Range (English) printed on 2 sides



Header Card 2 - Plus Range (English) printed on 2 sides



SKU NO.	SIZE	DESCRIPTION
1906426	60 cm x 42 cm x 105 cm	Three-Tiered 36pc Saw Bin (w/out Header)
1906428	60 cm x 54 cm	Header Card 1 fits 1906426 and 10507867
1906429	60 cm x 54 cm	Header Card 2 fits 1906426 and 10507867

COMPONENTS

Body

1 Inlay made of 6 parts

1 floor inlay

2 SAW BINS

Two type of saw bins:

Generic saw bin can contain 20 to 40 saws

Generic saw bin can hold up to 60 regular saws



SKU NO.	SIZE	DESCRIPTION
10507867	60 cm x 40 cm x 93 cm	20/40pc Saw Bin

COMPONENTS

Body

1 Inlay made of 6 parts

1 floor inlay

3 EURO SIZE PALLET WRAP WITH 2 HEADER CARDS

This Saw Display can contain up to 20 Shelf Packs (200 Saws).



2 Header Cards Plus Range (English) printed on 2 sides



SKU NO.	SIZE	DESCRIPTION
1906427	120 cm x 80 cm x 104 cm	Saw Pallet Wrap with 2 Headers

1 TAPE MEASURE COUNTER-TOP

Shipped flat-packed directly from the warehouse

Fits 3 shelf packs of any tape ordered.

Choose between HPP, MPP or OPP in all three sizes or Mix and Match according to the customers needs.



SKU NO.	SIZE	DESCRIPTION
10508085*	34 cm x 34 cm x 46 cm	Tape Measure Counter-Top Display

* Available while stocks last

COMPONENTS
Body Display
Header
3 Small Cardboard Boxes (to level items)

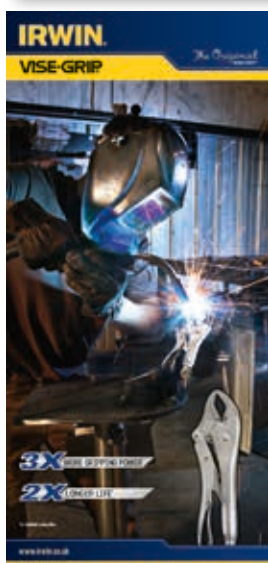

* Bespoke branded and product specific roll-up banners available on request

MERCHANDISING SOLUTIONS TO DRIVE YOUR SALES



Leverage your store environment and maximise your sell-out with flexible in-store solutions from IRWIN®.

Ask your sales representative - NOW!

NewellRubbermaid
Brands That Matter

